



De'Longhi America, Inc.
Park 80 West, Plaza One
Saddle Brook, NJ 07663
1-800-322-3848

De'Longhi Canada, Inc.
6150 McLaughlin Road
Mississauga, Ontario
L5R 4E1 Canada
1-888-335-6644

Fiducia Italiana S.A. de C.V.
Pestalozzi #814
Col. Narvarte
Del. Benito Juarez
C.P. 03100
tels: 5543 1447
lada sin costo: 01 800 711 8805

www.delonghi.com

**IMPORTANT INSTRUCTIONS
SAVE THESE INSTRUCTIONS**

**INSTRUCTIONS IMPORTANTES
CONSERVEZ LES PRÉSENTES INSTRUCTIONS**

**INSTRUCCIONES IMPORTANTES
REPASE Y GUARDE ESTAS INSTRUCCIONES
LEA ESTE INSTRUCTIVO ANTES DE UTILIZAR EL APARATO**

**ISTRUZIONI IMPORTANTI
CONSERVARE LE ISTRUZIONI**

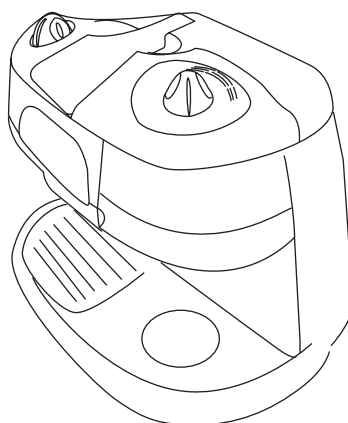

**BCO120T COFFEE CENTER, COFFEE, ESPRESSO AND CAPPUCCINO /
CAFETERIE MODÈLE BCO120T / CAFETERA ELECTRICA MODELO BCO120T /
MACCHINA DA CAFFÈ BCO120T**

Register this product on-line and receive a free trial issue of Cook's Illustrated. Visit www.prodregister.com/delonghi.
Visit www.delonghi.com for a list of service centers near you. (U.S. and Canada only)

Enregistrez ce produit en ligne et recevez un numéro gratuit de Cook's Illustrated. Visitez www.prodregister.com/delonghi.
Visitez www.delonghi.com pour y voir une liste des centres de réparation proches de chez vous. (É.-U. et Canada).

Registre este producto en línea y reciba un ejemplar gratis de Cook's Illustrated. Visite www.prodregister.com/delonghi.
Visite www.delonghi.com para ver la lista de centros de servicios cercanos a usted. (Estados Unidos y Canada)

Registra questo prodotto "on-line" per ricevere una copia omaggio della rivista. Visita www.prodregister.com/delonghi.
Visita www.delonghi.com per una lista dei centri di servizio a te più vicini. (Stati Uniti e Canada)

**ELECTRICAL CHARACTERISTICS: CARACTÉRISTIQUES ÉLECTRIQUES:
CARACTERISTICAS ELECTRICAS: CARATTERISTICHE ELETTRICHE:**

115 V ~ 60 Hz 1500W

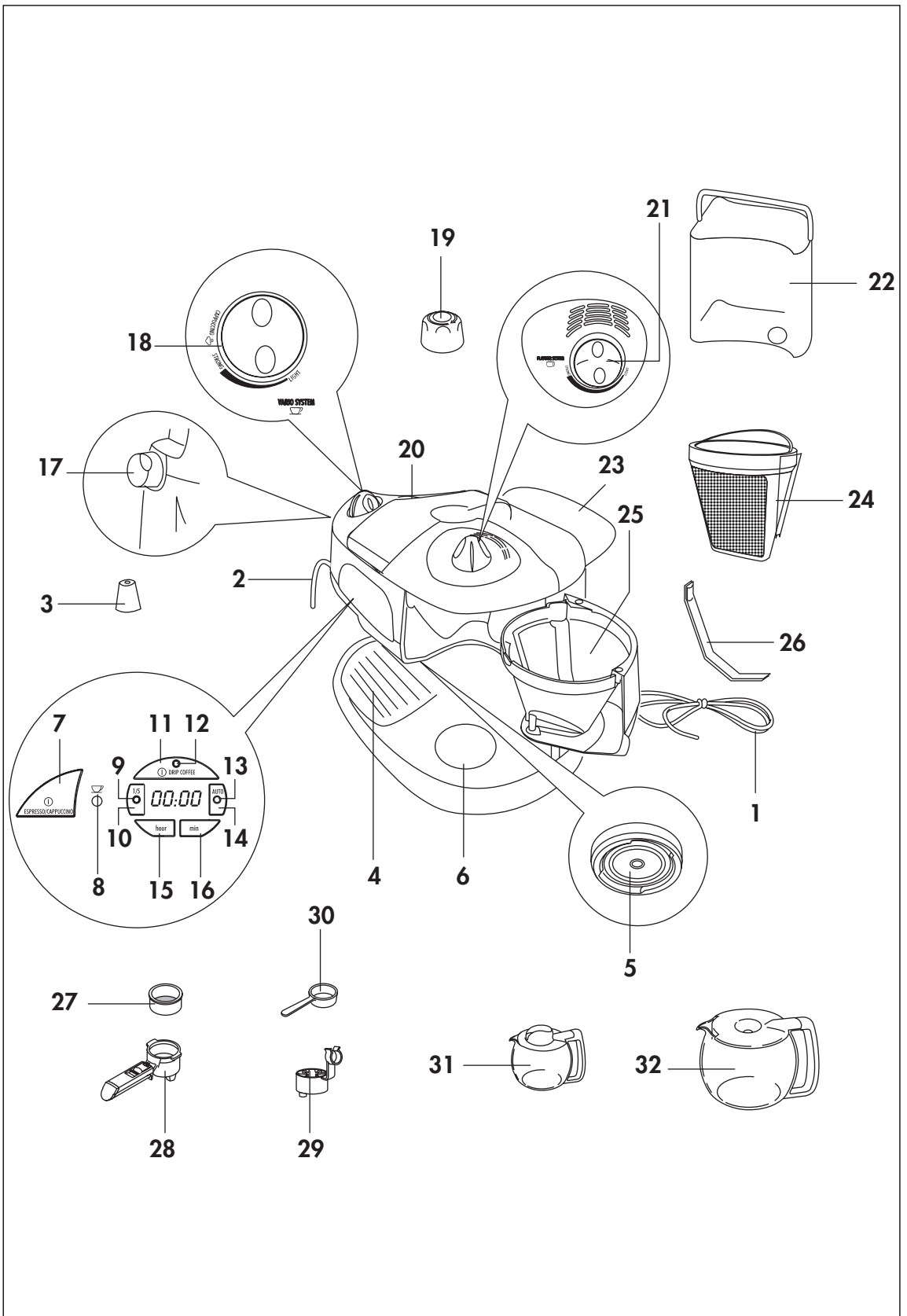

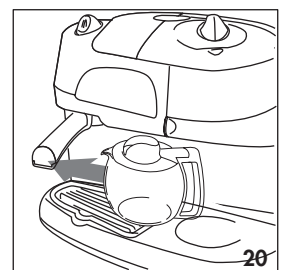
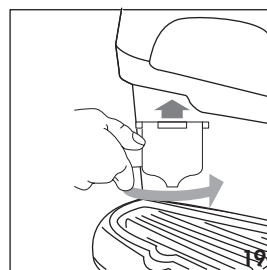
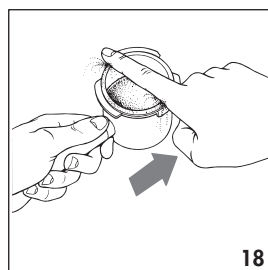
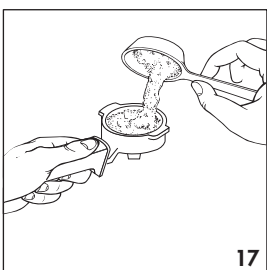
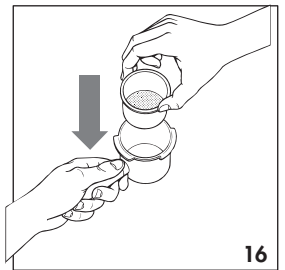
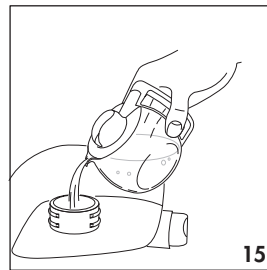
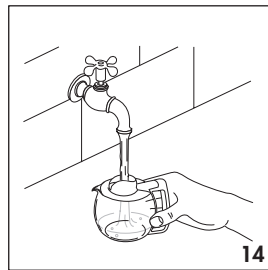
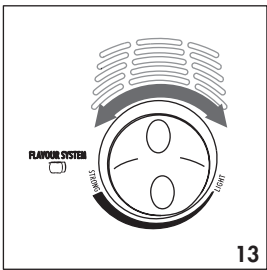
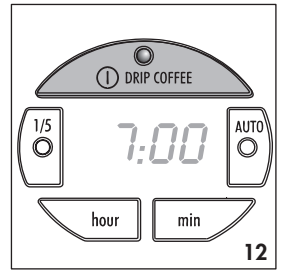
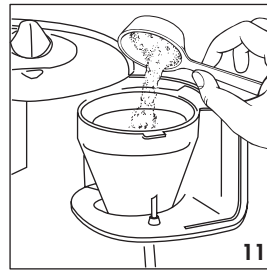
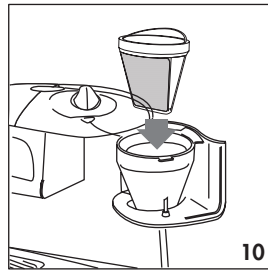
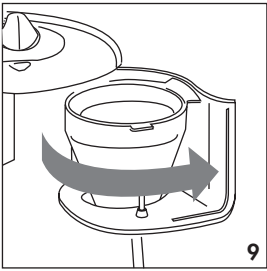
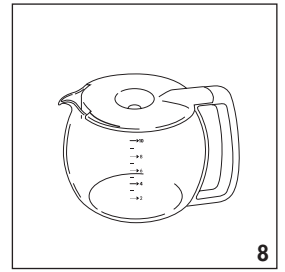
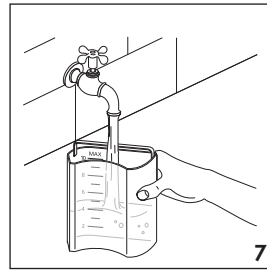
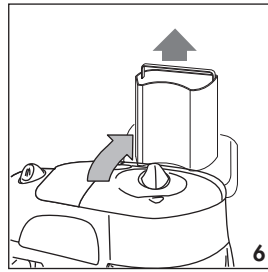
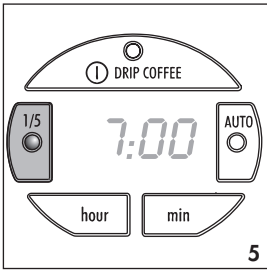
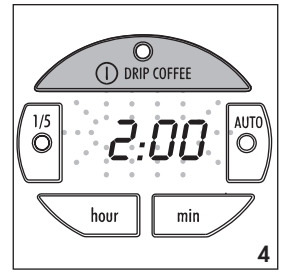
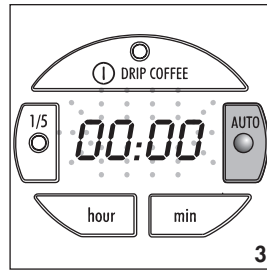
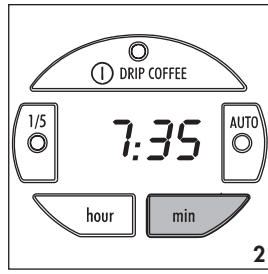
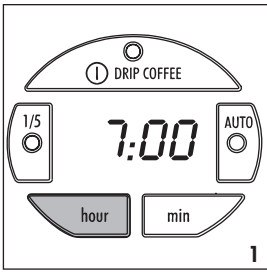

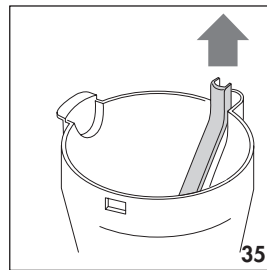
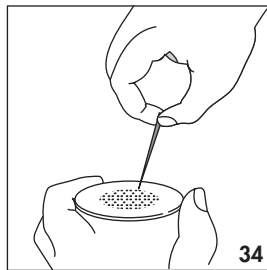
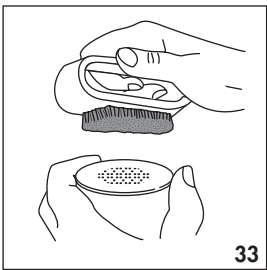
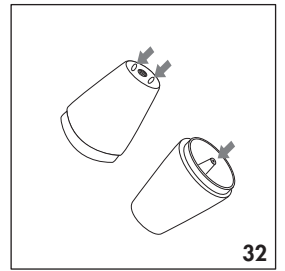
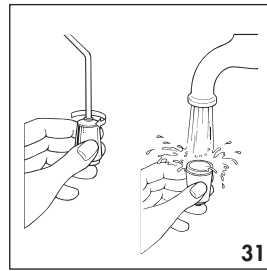
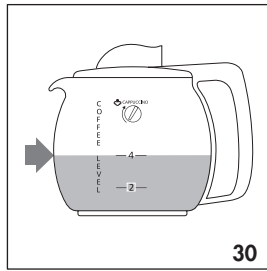
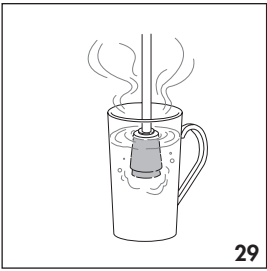
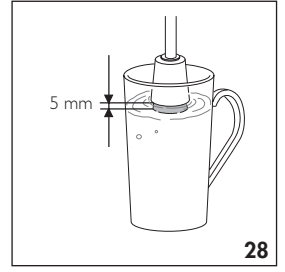
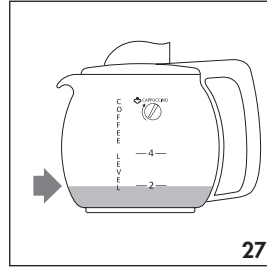
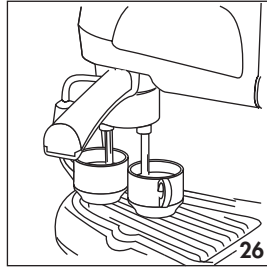
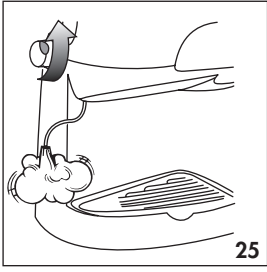
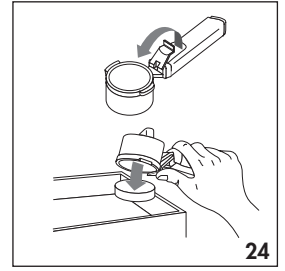
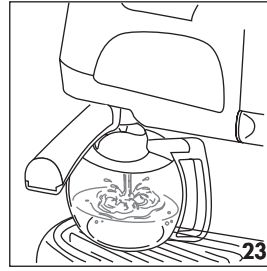
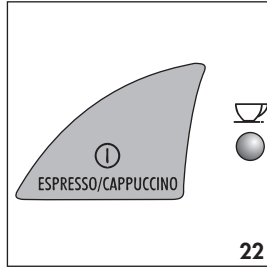

IMPORTANT SAFEGUARDS

When using any electrical appliance, some basic safety precautions should be observed. Specifically:

- Read all instructions carefully.
- Make sure the voltage of your electrical system corresponds to the voltage shown on the bottom of the machine.
- Do not touch hot surfaces. Use handles or knobs.
- To protect against fire, electrical shock and personal injury, do not immerse cord, plug, or appliance in water or other liquid.
- Keep the appliance out of the reach of children and do not leave appliance unattended while in operation.
- Disconnect the plug from the power outlet when the machine is not in use and before cleaning.
- Do not operate the machine with a damaged cord or plug, after faulty operation, or when it has been damaged in any way. Contact the nearest De'Longhi service facility for examination, repair or adjustment.
- The use of accessories not recommended by the manufacturer may result in fire, electrical shock, or personal injury.
- Do not use the machine outdoors.
- Make sure the power cord does not hang over the edge of the table or counter-top to avoid getting accidentally caught or entangled.
- Do not place the machine or its electrical parts on or near electric stoves, cooking surfaces, or gas burners.
- To disconnect the appliance, turn appliance "OFF", then remove plug from wall outlet.
- Do not use this machine for any purpose other than its intended use. This appliance is for household use only. The manufacturer declines all responsibility for any damage caused by improper, incorrect, or irresponsible use.
- For machines with glass carafe:
 - A. The carafe is an accessory to be used exclusively with this appliance. Never use it on a cooking surface.
 - B. Do not set the hot container on a damp or cold surface.
 - C. Do not use the carafe if it is cracked or the handle is not completely sturdy.
 - D. Do not use abrasive detergents or sponges to clean.

WARNING: To prevent the risk of fire or electric shock, never remove the upper part of the appliance. There are no elements inside that the user needs to access. Any necessary repairs must be made by an authorized service center.

SAVE THESE INSTRUCTIONS

THIS APPLIANCE IS FOR HOUSEHOLD USE ONLY.

SHORT CORD INSTRUCTIONS

A short power cord is provided to reduce the risk resulting from entanglement or tripping over a longer cord. Longer detachable power supply cords are available and may be used if care is exercised in their use. If a longer detachable power cord or extension cord is used (1) the marked electrical rating of the extension cord should be at least as great as the electrical rating of the appliance, and (2) the longer cord should be arranged so that it will not drape over the countertop or table top where it can be pulled on by children or tripped over unintentionally. The electrical rating of the appliance is listed on the bottom of the unit. If the appliance is of the grounded type, the extension cord should be a grounded type 3 wire cord. This appliance has a polarized plug. One blade is wider than the other. To reduce the risk of electrical shock this plug will fit in a polarized plug only one way. If the plug does not fit, contact a qualified electrician. Do not attempt to modify the plug in any way.

DESCRIPTION (see illustration on page 3)

The terminology below will be used throughout the instructions.

1. Power cord
2. Steam spout
3. Cappuccino maker
4. Drip tray
5. Boiler filter disk for espresso coffee
6. Warming plate
7. Espresso/Cappuccino ON/OFF button
8. Espresso/Cappuccino ON light
9. 1-5 cups indicator light
10. 1-5 cups selector button
11. Drip coffee ON/OFF button
12. Drip coffee ON light
13. AUTO ON light
14. AUTO button (automatic switch-on)
15. Hour set button
16. Minute set button
17. Steam knob
18. Vario System Flavor Selector for espresso coffee
19. Boiler cap
20. Boiler for espresso coffee
21. AccuFlavor System selector for drip coffee
22. Drip coffee water tank (removable)
23. Water reservoir lid
24. Drip coffee filter
25. Drip coffee filter-holder
26. Flavor Savor channel
27. Espresso coffee filter
28. Espresso coffee Filter-holder
29. Espresso coffee two-cup adapter
30. Measuring spoon
31. Small carafe for espresso
32. Large carafe for drip coffee

SAFETY PRECAUTIONS

- This appliance is designed to make coffee and other hot beverages:

Be careful not to burn yourself with sprays of hot water or steam, or by using the machine improperly.

- This appliance is designed for household use only. Any other use is considered improper and therefore dangerous.
- The manufacturer may not be held liable for any damage caused by improper, incorrect, or unreasonable use.
- When using the appliance, do not touch the hot surfaces. Use knobs or handles.
- Never touch the appliance with wet or damp hands or feet.
- Do not allow children or unfit persons to use the appliance unsupervised.
- Never allow children to play with the appliance.
- In the event of failure or malfunction, switch off the appliance and do not tamper with it in any way. If the appliance requires repair, contact an authorized De'Longhi service center and ask for original spare parts to be used. Failure to observe these safety precautions could jeopardize the safety of the appliance.

INSTALLATION

- After removing the packaging, make sure the product is complete and in perfect condition. If in doubt, do not use the appliance and contact qualified De'Longhi personnel only.
- The packing elements (plastic bags, Styrofoam, etc.) should be kept out of the reach of children, as they are safety hazards.
- Place the appliance on a firm level surface far from water faucets, sinks, and heat sources.
- When positioning the appliance on the counter, make sure to leave a space of at least 2 in. (5 cm) between the appliance and the walls or objects beside and behind it, and at least 8 in. (20 cm) above it.
- Never install the appliance in a room where the temperature may reach 32°F (0°C) or lower (the appliance may be damaged if the water freezes).
- Check that the voltage of the electrical mains corresponds to the voltage shown on the appliance rating plate. Connect the appliance only to an efficiently grounded outlet with a minimum rating of 10A only. The manufacturer may not be considered liable for possible incidents caused by the failure to adequately ground the outlet.
- If the power socket does not match the plug on the

appliance, have the socket replaced with a suitable type by a qualified electrician.

- The power cord on this appliance must not be replaced by the user, as this operation requires the use of special tools. If the cable is damaged or needs to be replaced, contact an authorized De'Longhi service center only in order to avoid all risks.

HOW TO MAKE DRIP COFFEE

SETTING THE CLOCK

When the coffee machine is connected to the outlet for the first time, the numbers 0:00 will flash on the display.

To set the time, proceed as follows:

1. Press the "HOUR" button (Fig. 1) for about 2 seconds until the number of hours on the display begins to increase.
2. Before the display stops flashing (about 5 seconds), set the hour by pressing the HOUR button repeatedly.
3. Set the minutes by pressing the MIN button (Fig. 2) repeatedly. (To speed up the operation, hold the button down.)
4. After setting the time, wait 5 seconds. When the display stops flashing, the time set is stored.

To reset the time, press the HOUR button for about 2 seconds, and then follow the procedure as described starting from point 2.

In the event of a temporary power failure, the time set does not remain stored in the memory.

PROGRAMMING THE AUTOMATIC START

(AUTO BUTTON)

The appliance can be programmed to make drip coffee automatically.

First, make sure that the time is set correctly.

To set the delayed start (i.e. the time you want the coffee to be made), proceed as follows:

1. Press the AUTO button (Fig. 3) for about 2 seconds until 0:00 flashes on the display.
2. Before the display stops flashing (about 5 seconds), set the desired hour by pressing the HOUR button repeatedly.
3. Set the minutes by pressing the MIN button repeatedly.
4. After 5 seconds, the display will stop flashing and the programmed time will be stored.
5. After you have programmed the machine as described above, just press the AUTO button to have coffee made at the time set (the AUTO indicator light will illuminate).

If you want to change the delayed start time after it has been set, press the AUTO button for about 2 seconds and then set a new time as described starting from point 2.

Keep in mind that at the time set, the appliance will start to make drip coffee only. The espresso maker does not come on.

LENGTH OF WARMING TIME (AUTOMATIC SHUTOFF TIME)

The appliance is factory-set to keep the coffee warm for two hours after startup.

However, this setting can be changed as follows:

1. Press the **Ⓛ** DRIP COFFEE ON/OFF button (Fig. 4) for about 2 seconds until 0:00 flashes on the display.
2. Modify the time by repeatedly pressing the HOUR button (and also the MIN button if required).
3. After setting the time, wait 5 seconds. When the display stops flashing, the time will be stored.

Note: If 0:00 is set, the appliance keeps the coffee hot for an unlimited period.

1-5 CUPS SETTING

To improve extraction and the aroma when making less than 6 cups, press the 1-5 cups selector button (Fig. 5). The 1-5 cups LED will light up.

MAKING DRIP COFFEE

- Lift the cover and remove the water tank (Fig. 6).
- Fill the tank with cold clean water up to the level corresponding to the number of cups of coffee you want to make (Fig. 7).

You can also leave the tank in the appliance and fill using the drip coffee carafe marked with the levels (Fig. 8).

- Replace the tank in the appliance and press it down gently.
- Open the filter-holder by turning it toward the right (Fig. 9) and pulling it out by the handle.
- Position the filter in the filter-holder (Fig. 10).
- Place the ground coffee in the filter using the measuring spoon provided and level evenly (Fig. 11). As a general rule, use one level spoonful of ground coffee (about 7 grams) for each cup (for example, 10 spoonfuls for 10 cups).

However, the quantity of ground coffee used may be varied according to personal taste.

Use good quality medium grind coffee for drip coffee machines.

- Close the filter-holder and place the carafe on the warming plate with the lid on.
- Choose the desired flavor as indicated in the

section "HOW TO CHOOSE THE FLAVOR OF DRIP COFFEE".

- Press the **Ⓛ** DRIP COFFEE ON/OFF button (Fig. 12). The indicator light on the button comes on and the appliance starts to make the coffee. (To make coffee at the programmed time, press the AUTO button (Fig. 3); the AUTO light on the button comes on.)
- The coffee will begin to emerge after a few seconds.

It is completely normal for the appliance to release a little steam while the coffee is brewing.

To keep the coffee hot after brewing, set the carafe on the warming plate and leave the appliance on (drip coffee indicator light on). The coffee in the carafe is kept at the right temperature.

- To turn the appliance off, press the **Ⓛ** DRIP COFFEE ON/OFF button.

HOW TO CHOOSE THE FLAVOR OF DRIP COFFEE

The coffee machine has a "flavor savor" channel inside the drip coffee filter-holder that increases the coffee infusion time, improving extraction. The resulting coffee has a full and intense flavor.

You can set the machine to make coffee with a strong (STRONG position) or light (LIGHT position) aftertaste by turning the AccuFlavor System knob (Fig. 13).

The AccuFlavor System only changes the strength of the aftertaste of the coffee, while the actual flavor remains unaltered.

HOW TO MAKE ESPRESSO COFFEE

1. Unscrew the boiler cap by turning it counter-clockwise.
2. Fill the small carafe for espresso with the quantity of water (Fig. 14) corresponding to the number of cups you want to make, using the marks on the WATER LEVEL side of the carafe (see the table at the end of the instructions).
3. Pour the water into the boiler (Fig. 15).
4. Close the boiler cap by turning it firmly clockwise.
5. Place the filter for espresso coffee into the filter-holder (Fig. 16).
6. Fill the filter with ground coffee according to the quantity shown in the table at the end of the instructions and distribute evenly without pressing down (Fig. 17).

It is important to use top quality medium grind coffee to avoid blocking the filter while the coffee is being dispensed.

7. Remove excess coffee from the edge of the filter (Fig. 18).
8. To attach the filter-holder, position it under the boiler outlet with the handle towards the left (Fig. 19), and push it upwards while turning the handle firmly toward the right.
Always turn the handle as far as it will go.
9. Place the small carafe for espresso under the filter-holder (Fig. 20).
Make sure the filter-holder spouts are inside the opening in the carafe lid.
10. Turn the Vario System selector to the type of coffee you want to make: LIGHT or STRONG (Fig. 21).
11. Make sure that the steam knob is closed by turning it clockwise.
12. Press the  ESPRESSO/CAPPUCCINO ON/OFF button (Fig. 22) for espresso coffee. The espresso/cappuccino ON light will illuminate indicating the espresso coffee maker is operating.
13. After about two minutes, the espresso coffee starts to run out from the filter-holder spouts (Fig. 23).

CAUTION: To prevent splashes, never remove the filter-holder while the appliance is dispensing coffee.

14. When coffee no longer runs out of the filter-holder, press the  ESPRESSO/CAPPUCCINO ON/OFF button to turn the coffee maker off.
15. Pour the coffee into the cups.
16. To dispose of the used coffee grounds, unfasten the filter-holder. Block the filter using the lever incorporated in the handle and empty the grounds by turning the filter-holder upside down and tapping (Fig. 24).

CAUTION: Before removing the filter-holder, to avoid puffs of steam, completely eliminate any residual steam in the boiler by turning the steam knob counter-clockwise (Fig. 25).

NOTE: For safety reasons, when the boiler is hot the cap cannot be opened, but turns without catching. If you need to remove it for any reason, first vent all the steam in the boiler using the steam knob as described above.

USING THE TWO-CUP ADAPTER

The adapter must be used when you want to make coffee directly in the cups rather than in the carafe.

To apply the adapter, hook it onto the bottom of the filter-holder (Fig. 26).



IMPORTANT: When using the appliance for the first time, all the accessories and the internal circuits must be washed as follows:

- **DRIP COFFEE MAKER: Make at least two carafes of coffee without using ground coffee (following**

the instructions in the section HOW TO MAKE DRIP COFFEE).

- **ESPRESSO MAKER: Make at least four cappuccinos without using ground coffee and using water instead of milk (following the instructions in the section HOW TO MAKE CAPPUCCINO).**

HOW TO MAKE CAPPUCCINO

- To make two cappuccinos, prepare the espresso coffee as described in the section HOW TO MAKE ESPRESSO COFFEE from point 1 to point 11, but add the quantity of water required to make two cappuccinos up to level  2 on the WATER LEVEL side of the carafe, as shown in the table at the end of the instructions. (Note: the quantity of water for making cappuccinos is greater than that needed for espresso. The additional water is used to produce steam to froth the milk).
- Press the  ESPRESSO/CAPPUCCINO ON/OFF button for espresso coffee. The espresso/cappuccino indicator light will illuminate to indicate the espresso coffee maker is operating.
- Let the coffee drip into the small carafe. When the darker coffee (which is below the lighter colored cream) reaches level 2 on the COFFEE LEVEL side of the carafe (Fig. 27), position the Vario System selector on CAPPUCCINO (Fig. 21). This must be done with the utmost care. If the coffee goes above level 2, there will not be enough steam left afterward to froth the milk.
- Pour the coffee into two sufficiently large cups.
- Pour about 3.5 oz. of milk for each cappuccino you want to make into a container. **Use only fresh milk, not boiled and in particular not hot.** When choosing the size of container to use, keep in mind that the volume of the milk will double or triple.
- Immerse the cappuccino maker into the milk to about 5 mm (Fig. 28) and turn the steam knob counter-clockwise (Fig. 25) (how far you turn the knob determines the amount of steam that will come out). At this point, the milk begins to increase in volume and becomes creamier.
- When the volume of the milk has doubled, immerse the cappuccino maker down to the bottom to heat the milk (Fig. 29). Close the knob only after all the steam has been released from the boiler.
- Press the  ESPRESSO/CAPPUCCINO ON/OFF button to turn off the machine.

- Pour the frothed milk slowly over the coffee with the aid of a spoon, then sprinkle a bit of cocoa powder on top for a perfect cappuccino.
- To make four cappuccinos, repeat the previous steps, paying attention to the quantity of water, milk and ground coffee indicated in the table at the end of the instructions. Before positioning the Vario System selector in the Cappuccino position, let the coffee drip into the carafe until it reaches level 4 on the COFFEE LEVEL side (as shown in Figure 30).

IMPORTANT: The cappuccino maker must always be cleaned after each use. Proceed as follows:

- Remove the cappuccino maker by turning it clockwise (Fig. 31) and wash it thoroughly with warm water.
- Check that the three holes indicated in Fig. 32 are not obstructed. Clean if necessary using a pin.
- Clean the steam spout, being careful not to burn yourself.
- Screw the cappuccino maker back on.

CLEANING AND MAINTENANCE

- Before carrying out any cleaning operations, let the appliance cool down and unplug it from the mains outlet.
- Never immerse the coffee maker in water: it is an electrical appliance.
- Do not use solvents or abrasive detergents to clean the appliance. A soft damp cloth is sufficient.
- Clean the filter-holder, drip tray, boiler outlet, carafe and water tank regularly. Never wash the filter-holder in the dishwasher.
- Rinse all the components and clean the metal filter thoroughly with warm water and a small brush (Fig. 33).
- From time to time, check to make sure the holes in the espresso coffee filter are not obstructed. If necessary, clean using a pin (see Fig. 34).
- Check the Flavor Savor periodically, removing it from the filter-holder cone by pulling it upwards (Fig. 35). Clean it thoroughly and replace.

DESCALING THE ESPRESSO/CAPPUCCINO SECTION

Over time, heating the water used to make the coffee leads to lime scale buildup in the internal circuits of the appliance.

We therefore recommend that you descale the espresso maker every 2-6 months (depending on the hardness of the water and the frequency of use).

Proceed as follows:

1. Fill the small carafe with water up to level 4 on the WATER LEVEL side.
2. Dissolve 1 spoonful (about 15-20 grams) of citric acid (sold at drugstores) in the water.
3. Pour the solution into the boiler and screw on the cap.
4. Make sure the steam knob is closed and attach the filter-holder.
5. Place the carafe under the espresso filter-holder.
6. Turn the Vario System selector to LIGHT and turn the coffee maker on.
7. After a few minutes, the solution begins to run into the carafe.
Every now and then, turn the steam knob to let out a little of the solution from the cappuccino maker.
8. When all the solution has run through, turn the appliance off and let it cool down.
9. To eliminate the descaling solution residues, repeat steps 1 to 8 at least twice, using water only (without adding citric acid).

DESCALING THE DRIP COFFEE SECTION

Over time, the lime contained in the water will cause blockage that can prevent the machine from working properly.

The coffee machine is equipped with a system for controlling the amount of lime.



When the lime reaches a high level, the drip coffee ON light begins to flash: this means it is time to descale.

To descale, proceed as follows:

1. Fill the carafe with clean cold water up to the 4 cup level.
2. Dissolve 2 spoonfuls (about 30 grams) of citric acid (sold at drugstores) in the water.
3. Pour the solution into the water tank and place it in the machine.
4. Remove the filter from the filter-holder (to avoid contamination).
5. Place the carafe with the lid on the warming plate.
6. Press the  DRIP COFFEE ON/OFF button and let one cup of solution run into the carafe; then turn off the machine.
7. Leave the solution to work for one hour.
8. Turn the appliance back on and let the rest of the solution percolate through.
9. To rinse, run the machine with water only (no ground coffee) at least three times (three full water tanks).

Repair of damage to the coffee machine caused by lime scale is not covered by the warranty if descaling is not performed regularly as described above.

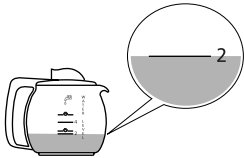
PROBLEM	POSSIBLE CAUSES	SOLUTION
No espresso coffee is delivered.	<ul style="list-style-type: none"> • The coffee is ground too finely. • The holes in the filter-holder spouts are obstructed. • The filter is clogged. 	<ul style="list-style-type: none"> • Use medium grind coffee or coffee ground expressly for espresso makers. • Clean the spout holes. • Clean the filter and holes thoroughly using a pin (see Fig. 34).
No milk froth is formed when making cappuccino.	<ul style="list-style-type: none"> • The milk is not cold enough. • The cappuccino maker is dirty. 	<ul style="list-style-type: none"> • Use reduced fat (or preferably fat-free) milk at refrigerator temperature. • Clean the cappuccino maker thoroughly.
The drip coffee takes longer to brew.	<ul style="list-style-type: none"> • The drip coffee machine needs to be descaled. 	<ul style="list-style-type: none"> • Descal as described in the section DESCALING THE DRIP COFFEE SECTION.
The coffee has an acidic taste.	<ul style="list-style-type: none"> • Inadequate rinsing. 	<ul style="list-style-type: none"> • Rinse the appliance as described in the section DESCALING THE DRIP COFFEE SECTION.

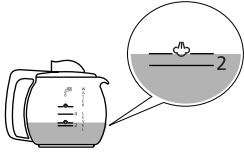
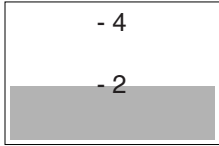
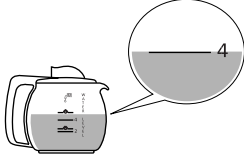
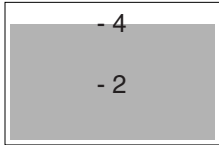
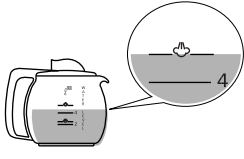
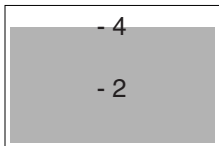
To make	Quantity of water in the small carafe to pour into the boiler (WATER LEVEL side)	Quantity of coffee to place in the filter
2 espressos		
2 cappuccinos		
4 espressos		
4 cappuccinos		



This warranty applies to all products with De'Longhi or Kenwood brand names.

Limited Warranty

What does the warranty cover?

We warrant each appliance to be free from defects in material and workmanship. Our obligation under this warranty is limited to repair at our factory or authorized service center of any defective parts or part thereof, other than parts damaged in transit. In the event of a products replacement or return, the unit must be returned transportation prepaid. The repaired or new model will be returned at the company expense.

This warranty shall apply only if the appliance is used in accordance with the factory directions, which accompany it, and on an Alternating current (AC) circuit.

How long does the coverage last?

This warranty runs for one year (1) from the purchase date found on your receipt and applies only to the original purchaser for use.

What is not covered by the warranty?

The warranty does not cover defects or damage of the appliance, which result from repairs or alterations to the appliance outside our factory or authorized service centers, nor shall it apply to any appliance, which has been subject to abuse, misuse, negligence or accidents. Also, consequential and incidental damage resulting from the use of this product or arising out of any breach of contract or breach of this warranty are not recoverable under this warranty. Some states do not allow the exclusion or limitation of incidental or consequential damage, so the above limitation may not apply to you.

How do you get service?

If repairs become necessary, see contact information below:

U.S. Residents:

Please contact our toll free hotline at 1-800-322-3848 or log onto our website at www.delonghi.com.

For all accessories, spare parts or replacement parts, please contact our parts division at 1-800-865-6330.

Residents of Canada: Please contact our toll free hotline at 1-888-335-6644 or log onto our website at www.delonghi.com.

Residents of Mexico: Please refer to the Limited Warranty statement for Mexico.

Please refer to the back page of the manual for De'Longhi addresses.

The above warranty is in lieu of all other express warranties and representations. All implied warranties are limited to the applicable warranty period set forth above. This limitation does not apply if you enter into an extended warranty with De'Longhi. Some states do not allow limitations on how long an implied warranty lasts, so the above exclusions may not apply to you. De'Longhi does not authorize any other person or company to assume for it any liability in connection with the sale or use of its appliance.

How does state law apply?

This warranty gives you specific legal rights, and you may also have other rights, which vary from state to state.